

# FRIGATE

---

Év / Year  
2020

**HU** Állítható magasságú forgószék

**EN** Height-adjustable swivel chairs

Tervező / Designer

**Kerégyártó András / András Kerégyártó**



PLYDESIGN

## HU

A székpálást két részből áll: a háttámlát 3D–furnér technológiával készítik, míg az ülésrészt hagyományos rétegeltlemez eljárással állítják elő. A háttámla, mely minden irányban ívelt, ideális támogatást nyújt a deréknek, annak felső részével és az ülőfelülettel együtt, ahol az élek a testtel ellentétes irányban kihajlanak, hogy ne vágják a hátat és a combot. A régi és az új technológiák ötvözete lehetővé teszi számunkra, hogy ugyanolyan optimális ülési kényelmet kínáljunk, mint más, teljes egészében 3D–furnérral készült székek, miközben sokkal szélesebb közönség számára elérhetővé tudjuk tenni. Az elegáns vonalak ellensúlyozzák a FRIGATE robusztus karakterét, amely az idő múlásának tökéletesen ellenáll.

### Méretetek:

Állítható magasságú forgószék:

615 × 645 × 800–880 mm (H × Sz × M)

Ülésmagasság: 445–525 mm

Ülésszélesség: 413 mm

Ülésmélység: 435 mm

Súly: 6,5 kg

Állítható magasságú görgős forgószék:

665 × 660 × 800–880 mm (H × Sz × M)

Ülésmagasság: 445–525 mm

Ülésszélesség: 413 mm

Ülésmélység: 435 mm

Súly: 7,5 kg

## EN

The chair's shell consists of two components: the backrest is made with the aid of 3D–Veneer technology, while the seat pan is produced through conventional moulded plywood process. The backrest, curved in all dimensions, provides an ideal support for the waist, along with its upper part and seat pan where the edges are bent in the opposite direction of the body in order to avoid cutting into the back and the thighs. The combination of old and new technologies enables us to offer an optimal seating comfort as other seats made entirely with 3D–Veneer, while making it available for a much wider audience. The sublime silhouettes counterbalance the sturdy character of FRIGATE which is designed to withstand the course of time.

### Dimensions:

Height-adjustable swivel chair:

615 × 645 × 800–880 mm (L×W×H)

Seat height: 445–525 mm

Seat width: 413 mm

Seat depth: 435 mm

Weight: 6,5 kg

Height-adjustable swivel chair w/ castors:

665 × 660 × 800–880 mm (L×W×H)

Seat height: 445–525 mm

Seat width: 413 mm

Seat depth: 435 mm

Weight: 7,5 kg



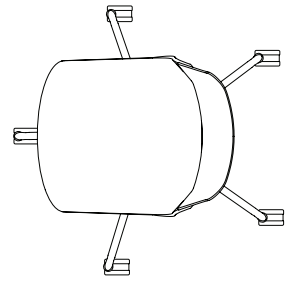
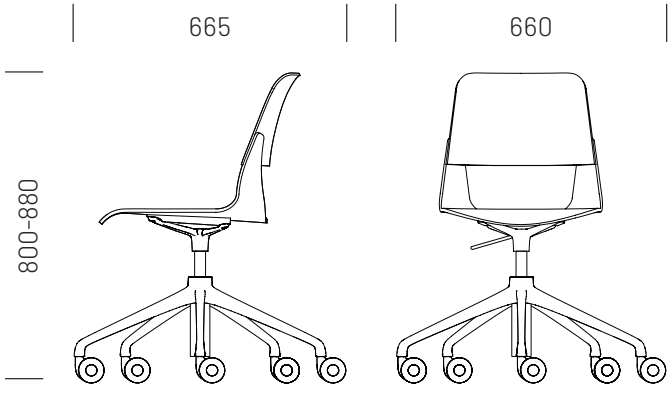
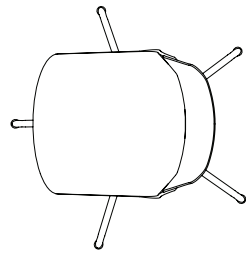
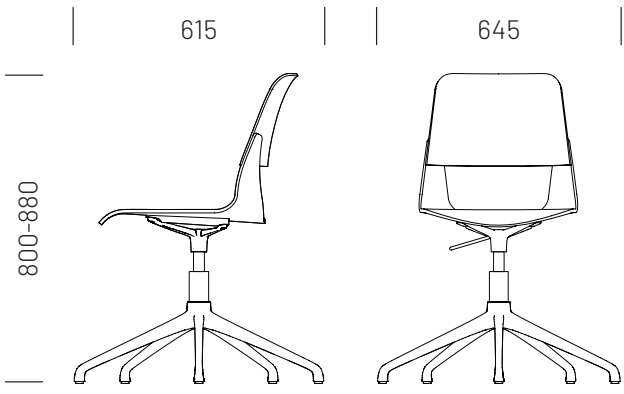

**Tanúsítványok/Certificates:**

Stabilitás és biztonság/  
Stability and safety:  
MSZ EN 12520:2016  
MSZ EN 16139:2013

Felületi ellenállás/  
Surface resistance:  
EN 12720:2009+A1:2013  
SIS 83 91 17 2) or EN  
15186 3)  
EN 12722:2009+A1:2013  
EN 12721:2009+A1:2013  
NS 8061  
EN ISO 105-E04:2013

A stack of curved wooden panels, likely made of plywood, with various colored veneers. The colors include natural wood grain, dark red, orange, green, and blue. The panels are stacked and curved, showing the layered structure of the material.

**Anyagok & *színopciók***  
**Materials & *colour options***

## PALÁST / SHELL

---

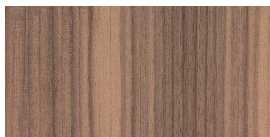

Amerikai dió/American walnut



Európai tölgy/European oak



Fehérített tölgy/Bleached oak



Törtfehér/Warm white



Barack/Peach



Bordó/Claret



Kék/Blue



Zöld/Green



Szürke/Gray

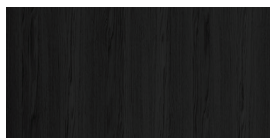

Fekete/Black

## BASE OF SWIVEL CHAIRS WITH CASTORS

---

## CASTORS

---



Polírozott alumínium/  
Polished aluminum



Fekete porfestett/  
Black powder-coated

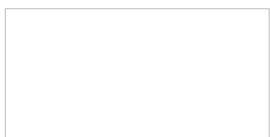

Fehér porfestett/  
White powder-coated



Fekete/Black



Króm/Chrome



Fehér/White

## BASE OF SWIVEL CHAIRS

---



Polírozott alumínium/  
Polished aluminum



Fekete porfestett/  
Black powder-coated

**ERA**

Tervezte: Penny Lovatt és  
 ánátszínezte: Morwenna  
 Fallows / Designed by Penny  
 Lovatt and recoloured by  
 Morwenna Fallows

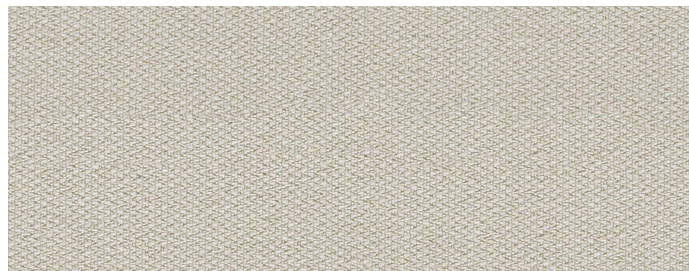

CSE01

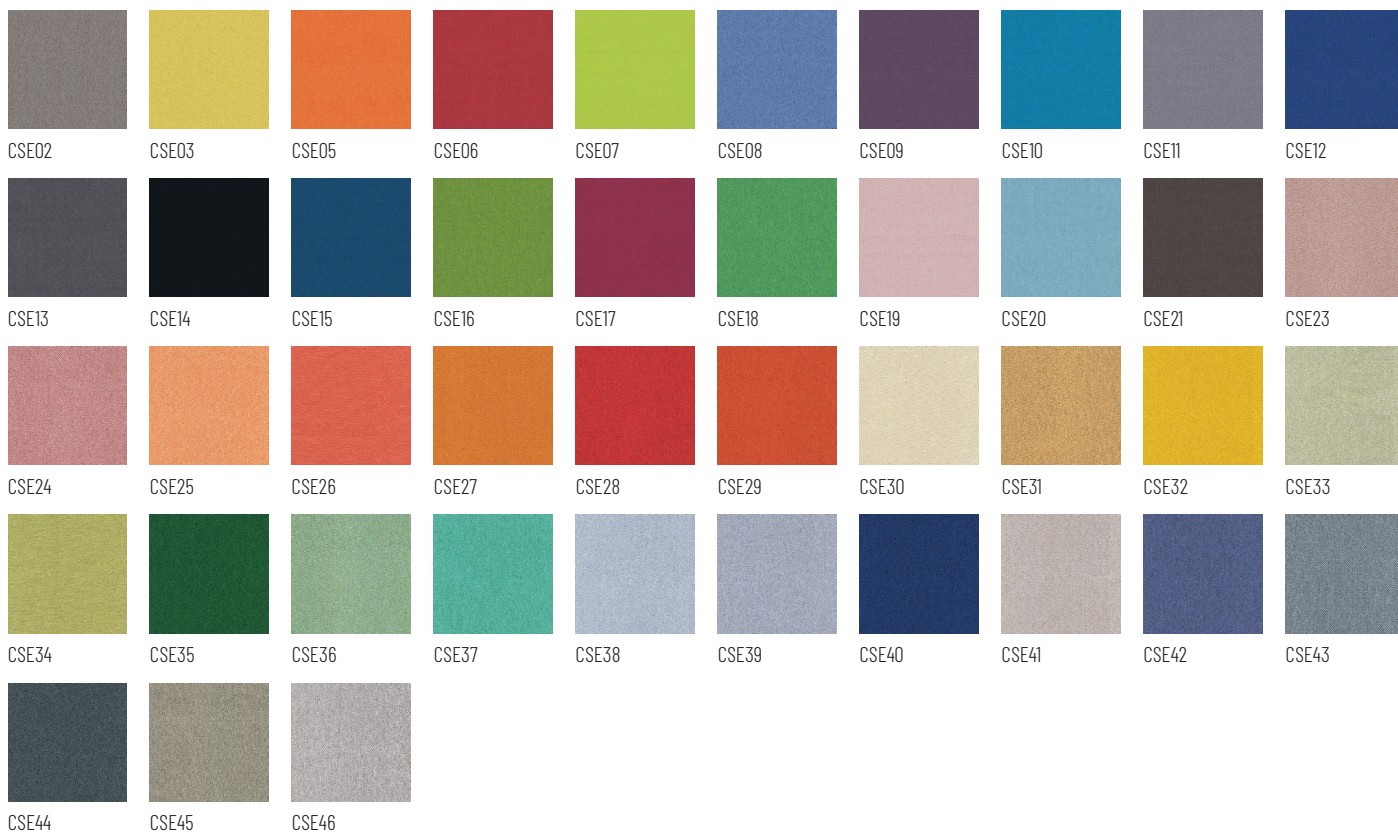

ÖSSZETÉTEL/COMPOSITION	TARTÓSSÁG/DURABILITY	FÉNYÁLLÓSÁG/LIGHTFASTNESS	PILLING	GYÚLÉKONYSÁG/FLAMMABILITY*	KÖRNYEZET/ENVIRONMENT
100% Poliészter/Polyester Fémmentes színezékek/Non metallic dyestuffs	≥ 100.000 Martindale	5	Száraz/Dry: 4 Nedves/Wet: 4	EN 1021 - 1 (cigaretta/cigarette) EN 1021 - 2 (gyufa/match) BS 7176 Alacsony veszélyesség/ Low Hazard	OEKO-TEX® Standard 100 Indoor Advantage™ „Gold”

\* További információt a [camirafabrics.com](http://camirafabrics.com) oldalon talál / Find more information at [camirafabrics.com](http://camirafabrics.com)

## STEP MELANGE

Tervezte: Inger Mosholt Nielsen /  
Designed by Inger Mosholt Nielsen

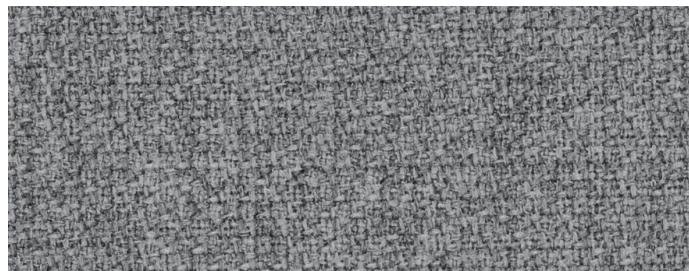

60004



ÖSSZETÉTEL/COMPOSITION	TARTÓSSÁG/DURABILITY	FÉNYÁLLÓSÁG/LIGHTFASTNESS	PILLING	GYÚLÉKONYSÁG/FLAMMABILITY*	KÖRNYEZET/ENVIRONMENT
100% Trevira cs	100.000 Martindale	5-7	4-5	IMO MSC 307(88) Annex 1 part 8 MED Certificate IMO IMO MSC 307(88) Annex 1 part 8 UK	STANDARD 100 by OEKO-TEX® EU Ecolabel

\* További információt a gabriel.dk oldalon talál / Find more information at gabriel.dk

ULTRA

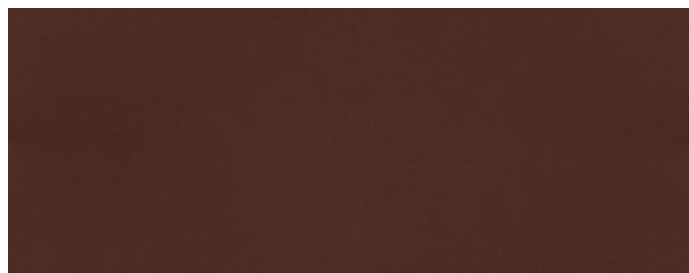

41598



ÖSSZETÉTEL/COMPOSITION	FÉNYÁLLÓSÁG/LIGHTFASTNESS	PILLING	GYÚLÉKONYSÁG/FLAMMABILITY*	KÖRNYEZET/ENVIRONMENT
Védett bőr/Protected leather	6-7	Száraz/Dry: 4-5 Nedves/Wet: 4	BS EN 1021-1 and 2 CA TB 117-2013	Krómentes VI/Free of chrome VI

\*További információt a [sorensenleather.com](http://sorensenleather.com) oldalon talál / Find more information at [sorensenleather.com](http://sorensenleather.com)